

QSA PE

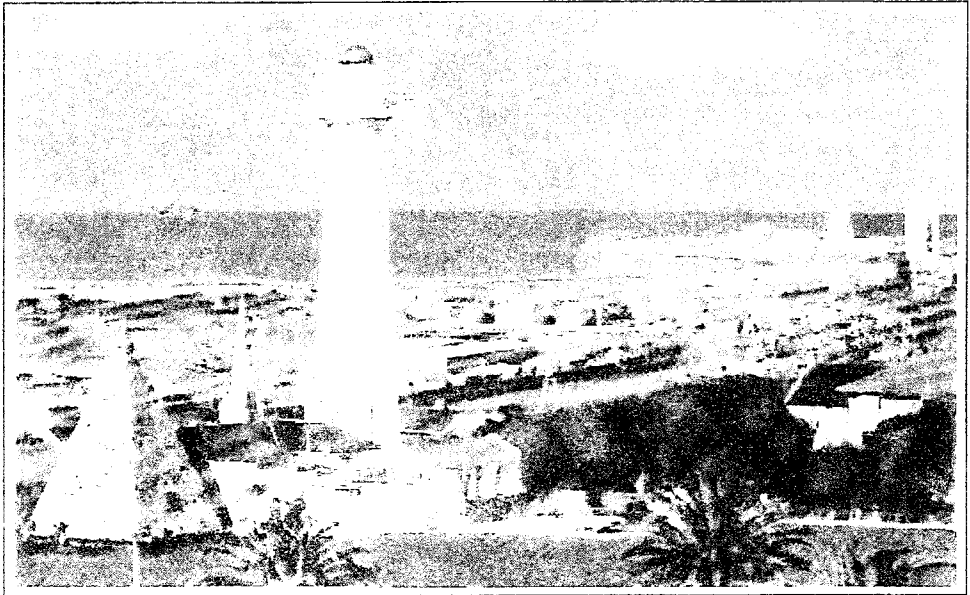

THIS NEWSLETTER IS PUBLISHED BY THE
PORT ELIZABETH AMATEUR RADIO SOCIETY

Web site: pears.8m.com

PO BOX 10402
LINTON GRANGE
6015

JUNE 2002

NOTICE OF MEETING

The monthly general meeting of the PORT ELIZABETH AMATEUR RADIO SOCIETY will be held on Friday 21 June 2002 commencing at 20:00 (8pm) in the Municipal Disaster Management Centre, Westview Drive, Mill Park, Port Elizabeth (Civil Defence Centre).

Mr. Hugh van Niekerk, of the local Weather Bureau, will put us wise about the activities of the Bureau and will also show us some slides, including those of his visits to Antarctica and the Island weather stations.

Tea, coffee and munchies will be laid on by OM Bill and may be had for a small donation in the receptacle provided.

Wrinkly Ravers

The next rave will be held on Thursday, 4 July 2002 at Guido's, in the Garden Spar shopping complex in Circular Drive, Lorraine.

The June Rave was held there and 19 Wrinklies turned up and enjoyed

themselves tremendously, so much so that they decided to return to the same spot next month.

Make a note of the date, and roll up from about noon. Smoothies are also welcome!

HAVE YOU JOINED/REJOINED THE SARL YET?

We are delighted to see that several PEARS members have been mentioned in the lists of new members of the SARL that have been broadcast on Sunday bulletins. As mentioned in QSX last month, the recovery of the SARL, especially following the *reduction* in subscription fees, is entirely dependent upon a sufficient number of new members coming into the organization.

A great onus rests on all existing members, in their own interests if nothing else, to encourage as many people as possible to join or rejoin the League. We need well over 300 new members in order to balance the books following the courageous SARL AGM decision to reduce subscriptions rather than increase

them as has been happening every year.

An indication of the SARL Council's determination to cut unnecessary costs is the decision not to introduce new Hamnet identity cards. Although a move in that direction had progressed almost to finality, our new Council decided wisely to scrap the idea and continue to use the old cards, which served their purpose adequately.

It is also good to see that several *volunteers* in Gauteng have been getting together at the NARC to help with various tasks. This suggests that a new ambience has developed at HQ and that we are perhaps at last getting back to *amateur* radio.

More strength to their arms! 

QSX by E-MAIL! If you want to receive QSX by e-mail (Pdf format) *instead of by post* please let the Editor know and provide your e-mail address. QSX will also appear on the PEARS web site (pears.8m.com) in future, but only several weeks after publication date. You will need Adobe Acrobat Reader.



The
Chairman's Chat

The AGM has come and gone, but what a happening it was! The weather was superb, it was well attended (nearly seventy bodies), and the socialising afterwards could not have been more pleasant. Yes, PEARS is a good club to belong to.

My thanks to the members for their confidence in re-electing me Chairman – just a pity about the salary though ...! Welcome to Cyril ZR2H who joins us on the committee, but he is not entirely a new boy as he has been there before. Otherwise it is pretty much business as before.

It was good to see the extent to which support for the 'new' SARL was shown, albeit cautious. A proposal that PEARS makes a donation of R1000 to the SARL to help offset the over-expenditure of the previous year elicited considerable debate. The meeting felt that the donation should only be made if the SARL delivered the goods, and it was therefore agreed that the proposal would be reconsidered in six months' time (at the November monthly meeting). By then it will be clear whether our expectations are being realised or not.

On the subject of the SARL, please do not forget to join / rejoin. We all said that if subs were reduced then we would join – now it's time to honour our side of the bargain.

Also do not forget to give Chris ZS2AAW your name for participation in the VW rally – we have a reputation to uphold!

73 & 88,

Beavan ZS2RL

HAMNET / ECARES NEWS

The storm conditions in the West Cape and the freak wave at Hermanus during May illustrates again that one never knows when and how a disaster may strike. All we can do is be reasonably prepared for such an event.

The lesson to be learnt here is not to build your house too near sea level, especially when facing the open sea. Part of disaster management is to try to avoid or minimize the consequences of any disaster.

Freak waves occur from time to time and should be borne in mind when building near the sea. The same applies to building on a river flood plain or on any unstable ground. A while ago a program on TV showed expensive houses built on a hill-top in California and with a beautiful view.

What the house owners were apparently unaware of was that the ground was unstable and during a rainy period the ground crumbled away into the valley below, taking several houses with it.

Fortunately we do not have volcanoes in South Africa. There must be thousands who have lost their lives through living at the foot of a volcano.

Hamnet Shield

At the PEARS AGM the Hamnet Shield was presented to Garth Laaks ZS2HB for

his assistance with the publication of Hamnet/ECARES News in QSX each month and also in other ways.

Six Metre Nets

Our six metre nets, which take place on Wednesday evenings at 20h00 on 52,950 MHz, have now been going for five and a half years! Not bad going.

We now also have a net in the Uitenhage-Despatch area on 51,400 MHz each evening at 20h00. Members currently participating are Ewalt ZS2EHB, Martin ZR2MR, Henry ZR2HPD, Tim ZR2TW and Lin ZR2LIN. Henry monitors this frequency 24 hours a day. Nice work, chaps.

New Member

Welcome to Ewalt Bouwer ZS2EHB, who has also joined ECARES. Glad to have you too, Ewalt.

Social

Jim ZR2JRD is still suffering with ill-health. Our thoughts are with you and we wish you well, Jim.

73,

AI ZS2U
Provincial Director,
Hamnet East Cape/ECARES



HAVE YOU RENEWED YOUR SUBS?

PEARS annual subs are R50 for full members, R30 for Spouse and Student categories. Subs fell due on 1 April. If you do not hurry and cough up we will be forced to remove your particulars from the membership register and circulation list for QSX. Don't say we didn't warn you!

While you're about it, why not write out that cheque for your SARL membership too?

FOR SALE ★ WANTED ★ SWOP

FOR SWOP

* 10 Metre and 6-metre converted CB transceivers to swop for model radio control servos – Viv Moore ZS2VM, tel. 368-1340.

PEARS AGM 2002

Nearly 70 members and family members as well as visitors attended the AGM, which was held in the Kabega Scout Hall instead of the originally announced Walmer hall, which we discovered in the nick of time had been double-booked.

Some members managed to palm off some junk onto other eager buyers at the boot sale before the AGM opened. After observing a moment's silence in memory of those who had gone "silent key" during the past year, the minutes and reports were accepted and confirmed without much ado.

The following PEARS trophies and awards were presented:

Ou Toppie Award ZS2SP

Appreciation Certificates:

ZS2AJ for SciFest assistance, especially manning thereof

ZS2AE for QSX circulation functions

ZR2EY for QSX circulation functions

ZS2EHB for support of PEARS special events.

ZR2MR for assistance at SciFest and general Amateur Radio promotion

Achievement Certificates

ZS2ACP for satellite work

ZS2AAW for repeater work

Trophies

ZS2OB DX Trophy – ZS2BWB

ZS2AB Constructors Trophy – ZS2R for the Frequency Counter

Ham Spirit Trophy – ZS2ABZ

PEARS Merit cup – ZR2NT

Hamnet shield -- ZS2HB (presented by ZS2U)

Special award – ZS2HB for QSX

The following certificate and awards that had been presented at the SARL AGM were also handed over by the Chairman:

Hamnet 40m Contest – ZS2U

Arthur Hemsley 2m Trophy – PEARS

Gary Immelman RA Heritage Award floating trophy – ZS2FM

Jack Twine Merit Award ZS2HB

Lionel ZS2DD relieved Beavan ZS2RL of his seat and called for nominations for

the post of Chairman. The only nominee was Beavan, so he returned to the hotseat re-elected for another year. This, of course, is a great compliment to the committee members. Who but a fool would want to work with a bunch of clowns for another year?

Neil ZR2NT decided he couldn't, muttering something about pressure of other matters, and he was replaced by Cyril Hislop ZR2H, who was nominated and elected to the committee while someone distracted his attention.

The rest of the outgoing committee accepted re-election which, one might think, speaks well of the Chairman for the aforementioned reason *mutatis mutandis*.

Al Akers ZS2U agreed to take responsibility for RAE training and administration but was not keen to accept election to committee. Smart lad, that Al!

The motion by the Committee to amend the Constitution to provide for membership by other clubs and entities was accepted unanimously.

Beavan appealed to members to join or rejoin the SARL. A show of hands indicated that, of those present, 19 were already SARL members, 6 had rejoined, and another 12 promised to do so.

Garth spoke about the important changes that had taken place at the SARL AGM recently which augured well for the future but could only succeed if sufficient new members enrolled soon. All who had complained of rising subscription fees and high-handed management should now put their money where their mouths are.

He also reported that the League had a deficit of some R29 000 in the current financial year and proposed that PEARS make a donation of R1000 to help eradicate it and give the League's renaissance under new management a kickstart. It was decided to review the proposal six months hence in the light of the improvement expected in the League's performance.

After the closure of the meeting, the braai was enjoyed in excellent weather. ☺

SARL MATTERS

INAUGURAL SPEECH OF NEW PRESIDENT

In his inaugural speech at the SARL AGM dinner on 20 April, the newly elected President of the South African Radio League, Sid Tyler ZS6AYC, said:

"To me it is both a privilege and a pleasure to be in this position where I can represent both amateur radio and the South African Radio League. I am also proud to be a member of the SARL.

"I would like to thank the members and my fellow councillors for the confidence they have shown. I will do the very best I can for the South African Radio League and of course also for amateur radio in general.

"My thanks also go to the outgoing President, Hans Potgieter ZS6ALJ, for all the work he did and the results achieved during his term in office. He built, with council, a platform on which we can build the future of amateur radio.

"Thanks also to the wives and families of the council members, for their support to the men on the SARL council.

"By this time we have all heard of the revolutionary budget which was approved at the AGM. As was clearly stated in the AGM, *the workability of this budget depends on the SARL obtaining an increase in membership*. I must ask all SARL members, but especially the club chairmen and their committees, to help with this. The required membership increase cannot be achieved by council members only, they are too few by far.

"This is important because there is an element of risk involved in the budget – we hold the future of amateur radio in our hands. We are challenged to ensure that the South African Radio League remains a proud organisation and that amateur radio remains a viable hobby. I believe

that this can be done if we work together."

SURPRISE FOR NEW MEMBERS

A pleasant surprise is awaiting three new members who join the SARL before July 12. Three items have been donated to the SARL for which three names will be drawn from only those who join before July 12. The items are:

- A home alarm system;
- A telephone intercom system and;
- A universal remote control system for TVs etc.

■ The SARL bulletin announcement did not mention that the items were donated by our own Rory Norton, ZS2BL in the interests of rebuilding the League and thus furthering our hobby. Many thanks, Rory!

RESULTS OF MAY RAE PROCESSED IN RECORD TIME

The results of the RAE that was written on 23 May were not only announced just a week later but each candidate who passed and had completed a licence application form was also issued with a call sign. Councillor Rassie Erasmus ZS1YT, whose task it is to set and mark the papers, is to be congratulated on a stout effort once again.

Of the 113 candidates who wrote the examination, only 95 were successful in spite of the reversion to the lower pass requirement after the temporary raising of the required levels. This suggests that many candidates went in unprepared.

Not so the candidate with the highest marks – Dr G.A. Keen of Cape Town – who achieved 100% in both the papers. The youngest candidate to pass the class A examination was 15 year old

Q.D. du Preez of Durban. The oldest was 72 year old Charlie Stevens of George, who now boasts the call sign ZR1AWG.

Charlie formerly held a ZS6 call sign but let his licence lapse some 30 odd years ago. He has renewed his interest in ham radio since moving to George but had to write the RAE (which did not exist when he first came on the air) and he must again pass a morse test to get back on HF.

■ The minimum pass level for each of the two RAE papers was raised last year from 40% (with an aggregate of 50% for the two papers) to 50% (aggregate 65%) but has been reduced again because the amendments to the Radio Regulations have not yet been approved and published.

SARL FIRST LADY GETS LICENCE

It was great news to learn that Adele Tyler, XYL of the President of the SARL Sid Tyler, has passed the RAE and now boasts the call sign ZR6APT. *Congrats, Adele!*

HAMNET ID CARDS

Council recently decided to retain the old and established HAMNET ID card in rather than adopt a proposed new design.

If you are a member and have the old card, you need not take any action. It is valid and can be used. Those who do not have a card should get in touch with Al Akers ZS2U.

An ID card needs a recent photograph of you. The new drivers' licence I.D photo is the correct size. Please put your call sign on the reverse for identification.

ROGER'S ARTICLES FOR RADIO ZS GET THE OK AGAIN

We were happy to learn that, wasting no time after taking up the reins, the incoming President, Sid Tyler ZS6AYC has cleared the air with Roger ZS1J after the unpleasantness that had arisen a year or so ago. Members may recall that, perhaps in an ill-considered moment of pique, Council under his predecessor had ruled that no further articles written by Roger should be published in Radio ZS.

Sid assured Roger that his articles would be welcomed again. No doubt most readers will be glad to hear this and will look out for Roger's interesting and informative items. They are an asset that on occasions earn a place even in internationally known ham publications.

• Roger has rejoined the League.

VW RALLY 19/20 JULY

The Algoa VW Rally will be run on Friday and Saturday, 19 and 20 July this year.

Chris ZS2AAW is organizing the communications network and will be happy to hear from all who will be able to assist.

In the mean time, you may wish to check over your equipment if you plan to participate and ensure that all is in order for the event.

We will no doubt have some details of the route and number of stations

needed by the June meeting of PEARS.

Since our July meeting would normally take place on Friday, 20 July, thus clashing with the Rally, the meeting will doubtless be brought forward to the Wednesday as in the past in order to facilitate final briefing and handout of stickers, forms etc.

Please keep an ear open on bulletins and check next month's QSX for more up-to-date information regarding the meeting and the rally. **Q**

by Allan Whitehead ZS2R

In part 2 of this series an error occurred in the circuit of a non-inverting amplifier. Inputs 2 and 3 need to be interchanged and the gain formula would be: $gain = 1 + R_2/R_1$. Hats off to all those that spotted the error and apologies to those that did not! The corrected circuit is given below.

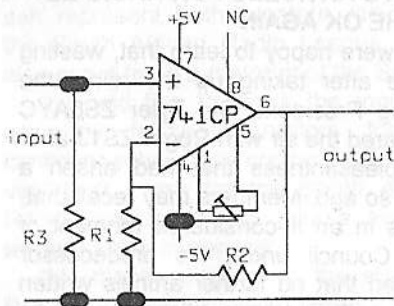

Non-inverting Amplifier

Many op amps are used to amplify only A.C. signals and then also with a single power supply. In audio and RF applications, DC offsets are of no consequence as the input and output are blocked by capacitors.

However provision must be made to keep the DC level of the input and output about half way between the single supply voltage and ground. This is accomplished by connecting a voltage divider consisting of two equal resistors between ground and the supply.

The voltage $V/2$ can now be used to set the level of one of the op amps' inputs. If the other input is also at $V/2$ the output will also be at $V/2$. The next circuit will illustrate this technique.

The following circuit is a simple op amp audio amplifier that could be used as a microphone preamplifier. It would be an interesting exercise to compare

the component count with that of other published preamplifiers.

This circuit is simple and could provide an ideal experiment. The frequency response can be quite easily adjusted by changing one or two components. Note that in this arrangement no offset adjustment is necessary.

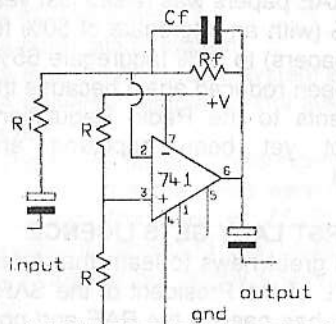

The supply voltage in this case could be anything between 5V and 15V. R_i will be the input resistance and could be made equal to the output impedance of the microphone or any other desired value.

The gain of the amp will be determined by R_f/R_i . If a pot. or a trimpot is used for R_f the gain can be adjusted conveniently.

The high frequency response can be adjusted by changing the value of C_f . The higher the value of C_f the greater the feedback at high frequencies and therefore the lower the gain.

If this amplifier is connected to a transceiver it is suggested that the gain is set at one to start with and gradually increased with due regard for the effects. Remember to check the output level of the op amp before applying an input signal. Ⓢ

Al Akers ZS2U

The QRP project was prompted by the tiny crystal controlled transmitter kits that were displayed and used at the Science Festival earlier this year. It foresees a group of members constructing basic transmitters (in essence crystal oscillators) and getting together for chats on the air.

A suitable circuit diagram appeared in the April issue of QSX.

Development of the basic rigs by the addition of modules is the natural outflow from the initial unit.

The project was unfortunately delayed pending the arrival of the crystals. However, hopefully the transmitters have been built in the meantime and can be put to use immediately because the crystals have now arrived.

Those who ordered one can pick it up from Clive ZS2RT. If you did not pay up front, you will need to give Clive your R50 so that he can balance his books.

If you have not planned to construct a QRP rig, simply turn down the drive on your normal transceiver and get your QRP this way.

In order to get the project going, will

all interested parties please let me know what days and times they can be operational so that I can co-ordinate and publicize the best times for members generally to listen and call.

I usually monitor Lady's Slipper and/or Town repeater and 52,950 MHz, and my telephone number is 041 360-2983, so do call me and let me have this information.

■ The following e-mail from Rory ZS2BL is relevant.

He wrote: "Bumped into this bloke's site with some interesting, simple radio projects ideal for beginners.

<http://www.intio.or.jp/jf10zl/>

He also came across this site and found a rather interesting design for a high gain 2m vertical antenna that should cost under R20 to build:

<http://www.angelfire.com/extreme/sideband/>

Follow the link to a blow-by-blow account of how to build it, including diagrams.

(I have not checked them out (my telephone bill was over R500 this month) but constructors may wish to have a look at the sites – Ed.)

CORRECTION — In Part 2 of this series, published last month, the formula quoted actually results in the dimension of a *full* wavelength. The result should be divided by 4 to determine a *quarter* wavelength.

The formula should therefore read:

$$l = 299.8 \times V / 4f(\text{MHz})$$

RADIO AMATEUR EXAMINATION IN OCTOBER

Al Akers ZS2U writes:

I have had my arm twisted to handle classes for the next RAE. Whether we do have classes or not will depend on how many applicants we get. Anyone interested in attending such classes or who knows of anyone who would be interested, please contact me as soon as

possible.

The next examination will take place on Thursday, 17 October. Applications to enter will need to reach the SARL by about 17 September.

PEARS RAE manuals are available from Clive Fife ZS2RT.

MINUTES OF THE MONTHLY MEETING OF THE PORT ELIZABETH AMATEUR RADIO SOCIETY HELD AT THE MUNICIPAL DISASTER MANAGEMENT CENTRE, MILL PARK, PORT ELIZABETH ON FRIDAY 19 APRIL 2002

1. PRESENT AND APOLOGIES:

As noted in the attendance register.
ZS2C, ZS2RL, ZR2AI, ZS2HB,
ZS2EHB.

2. WELCOME:

Chris welcomed all, standing in for the Chairman who was away in the Drakensberg

3. ACCEPTANCE OF PREVIOUS MINUTES:

Proposed: ZSR2NT
Seconded: ZS2AE

4. ARISING FROM PREVIOUS MINUTES:

None

5. FINANCE:

All is sound financially. Clive gave a report to the meeting.

6. CORRESPONDENCE:

In – Not opened as yet – committee meeting missed.

Out – Beavan sent the letter to ICASA w r t new regulated fees

7. GENERAL:

- Chris asked that the meeting propose names/call signs for the various awards that PEARS has available. A voting slip prepared by Beavan was handed out and members duly considered their votes.

- Andre, ZS2ACP donated a neat desk clock for the club to use as a fundraiser.

- Bill, ZS2BY asked for assistance in reformatting a HDD lost to a virus attack. Neil took up the challenge.

- Al – the QRP project has 11 crystal orders. Neil explained the problem with the first trial crystal received, and the

resultant delay while the problem is identified.

- Chris updated all present on the repeater interference traced by Andrew ZS2G and Colin, ZS6LP. He thanked them for their good tracking work. The offending station was reported to ICASA, who closed it down during the past week.

- Ken commented on the increasing use of CW in contests vs the decreasing voice trend.

- Neil announced the status of the frequency counter project, and asked for numbers of interested members if a kit were to be ordered. 5 hands were noted.

- Al mentioned the co-ordinated beacon system around the world, present in 59 countries, that each transmit at specified times at decreasing powers from 100W to 0.1W. It makes interesting listening, seeing whether you can receive the lower power signals.

- Rory suggested the club's participation in some form of public awareness special event. Neil suggested the Splash festival in 2003 as an option. The meeting agreed that a local event would be a lot easier to get going. Committee will look into it before the following year.

- 70cm beacon – Ken asked whether any thought had been given to getting a 70cm beacon up and running. Chris asked Al whether the UPE beacon could be augmented. Al would check it out.

The meeting closed at 20h30. Since there was no organised speaker, refreshments were enjoyed along with a good old chinwag! ☺

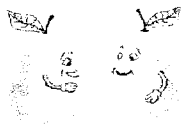

Peanstalk

TIPS ON WORKING THE ISS

With the possibility of more frequent contacts with hams aboard the International Space Station (ISS), the SARL's bulletin of 12 May provided the following comments on how to make voice contacts with those on board the ISS:

- ◆ Remember that the footprint of the ISS is essentially large enough to cover the whole of sub-Saharan Africa. That means that anyone in South Africa who is transmitting on the uplink frequency (144,200 MHz) may well be within "line-of-sight" of the ISS. This in turn means that the ISS crew can probably hear everyone calling on that frequency, no matter where they are on the sub-continent.

- ◆ Listen on the downlink frequency, which is 145,800 MHz, and *never* transmit on that frequency.

- ◆ If you hear an ISS operator, do not transmit unless you hear that he is calling you or inviting all calls. He may already be in QSO with someone else.

- ◆ Please keep quiet on the uplink frequency during QSOs that you can hear on the downlink. Note that, unless you are also monitoring the *uplink* frequency and the person in conversation with the ISS is located near you, you will only be able to hear the ISS side of the conversation. This means that there could be reasonably long periods of silence on the downlink frequency. The rule therefore is to listen, listen, listen, before calling.

- ◆ When you call, only give your call sign once (phonetically if you need to), then listen again until you are sure it will be correct to call again. Don't give the call sign of the ISS operator or use expressions such as "NA1SS, NA1SS. This is ZS6XYZ. Mark do you copy?". Keep your overs *short*, usually just your name and town or city and something like "thanks for the contact". *Do not try to engage the ISS operator in a*

normal type of QSO. There are probably many others trying to work the ISS during the short pass.

- ◆ Packeteers should also think of other hopeful users and not occupy the BBS aboard the ISS throughout the pass by repeatedly listing, downloading or uploading messages, none of which are likely to be of any real importance. Allow others to also enjoy the experience of perhaps their first contact with the ISS BBS.

ROGER'S BEACONS BACK

The QRP beacons that were operating from Roger's farm outside Plettenberg Bay since 1993, have been off the air for the past year or so but have returned.

The 3586 kHz signal was restored on 13 May and the 10125 kHz and 1817 kHz beacons followed shortly thereafter.

The output power of these beacons was reduced from their 200 mW down to 100 mW and a new keyer is programmed to indicate the output power.

The 200 mW 160 metre beacon could be heard at most times in Div 6 during the hours of darkness and the best DX report has been from 9J2BO. Reports of RST 559 have been received from Div 5 on the newly installed 80 metre beacon.

The beacon operating on 28.2025 MHz with the call sign of ZS1J/B remains unchanged, running 5 watts into an omnidirectional vertical antenna. This beacon can often be heard on backscatter with a beam firing due north.

Roger will appreciate signal reports, which can be emailed to him on whitewebbs@freemail.absa.co.za.

DAYTON HAMVENTION NEWS EXTRACTS

This year's Dayton Hamvention was the 50th anniversary of the event – and the 51st

show.

FCC Special Counsel for Enforcement, Riley Hollingsworth, said in his talk that amateur radio operators "have a lot to be proud of." However, he also issued a serious warning that there are too many amateurs who want to mess around on the air: *"To the extent that you tolerate these violations, you contribute to the decline of Amateur Radio," he said.*

Mr. Hollingsworth cautioned amateurs to be aware of how they might sound to others on the air, referring to "bar-room" type language or topics as well as arguing and infighting. Such misbehaviour *inter alia* distracts the licensing authorities' efforts from more important matters such as intruders on amateur bands.

Here in South Africa, our licensing authority ICASA has also warned hams to watch their behaviour on the air and called upon us all to pull up any offenders that we hear. It cannot be gainsaid that there is much room for improvement.

DIGI TO BE RECOMMISSIONED

The digipeater at Grahamstown is to be recommissioned, but unfortunately not as a Rose switch, says Chris ZS2AAW. The Rose firmware does not cater for UI frame digipeating on all ports, which means that it is no good for the APRS activity that is quite popular here at present.

Chris has been investigating a PC based setup to cater for both APRS and normal networking traffic, and he has got something running that does the job. He was hoping to install the same setup on Slipper to do similar digipeating there so that the APRS traffic could come in on the UHF backbone from GHT and be seen on the VHF ports in PE via Slipper – something the previous software could not do.

However, the BBS software is not Windows friendly, so he could not come right there either – they would both need to be upgraded together since they talk to each other.

Chris was also trying to get 9600 running on the backbone, so there were plenty changes – the end result: no success! So the BBS went back as a non-Windows version. The GHT digi will most likely go back as a Win98 version if Chris can ensure that the system runs on a UPS and will boot up properly in the event of a power failure – a major Windows problem on a remote site.

QRP ACTIVITY GROUP

Al Akers ZS2U reports:

The crystals for the QRP transmitters that a number of members plan to construct have arrived. Those who placed orders for them can pick them up from Clive ZS2RT.

If you did not pay up front, you need to give him your R50 when you collect your crystal.

The QRP project was delayed pending receipt of the crystals. Hopefully the transmitters have been built in the meantime or will be put together soon now that the crystals have become available. If not, turn down the drive on your normal transceiver and get your QRP this way.

In order to get this project going, will all interested parties please let me know what days and times they can be operational so that I can co-ordinate and publicize the best times for members generally to listen and call.

I usually monitor Lady's Slipper and/or Town repeater and 52,950 MHz and my telephone number is 041-3602983, so do call me and let me have this information.

DONATIONS TO PEARS

Sincere thanks to Donald Jacobs ZS2BW, Gus Winter ZS2MC, Colin and Elmien Porter ZS6RP and ZS6LMN, and André Botes ZS2ACP for their donations. Donald's contribution was offered for the maintenance of the PEARS repeater system, even though he is a full member of the Society and therefore entitled to use all our facilities.

André donated a desk clock which was

Recruit a member for the SARL today

raffled at the AGM and raised R119.80. In what was surely the swindle of the year, it was won by the Chairman, Beavan, who had taken ticket no. 1.

Ras ZR2MR (promoting interest in ham radio); Alan Whitehead ZS2R (frequency counter project) and Neil Thomas ZR2NT (PEARS Merit Cup). 

PEARS CONTEST WINNERS

Congrats to the following hams who won in their categories in the Division 2 segment of the PEARS National VHF/UHF contest in January:

- Al Akers ZS2U, both 50 MHz and 144 MHz Field Station categories;
- Anthony Marran ZR2AE, 432 MHz Fixed Station;
- Richard Seddon ZS2CLI, 144 MHz Fixed Station.

Well done, you guys.



LOCAL ENTRANTS PASS RAE

All four of the local entrants who wrote the recent RAE passed the exam and have their call signs (see page 14). A fifth candidate had entered but unfortunately failed to arrive at the venue.

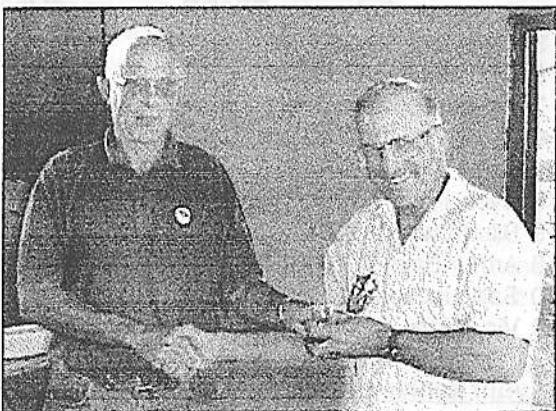

ARE YOU 80 OR NEARLY SO?

Members who turn 80 are presented with the "Ou-Toppie" fun certificate and, if they have also been a member of PEARS/the PE Branch for at least ten consecutive years, they are additionally granted free membership of the Society in terms of an amendment to our Constitution last year.

However, the Society has not kept a record of each member's year of birth or exactly when they joined PEARS (or the former PE Branch).

Members who will qualify either for the Ou-Toppie certificate or both the certificate and free membership are therefore asked to let the Committee have the necessary details *before* their 80th birthday, please.



SHOTS FROM THE AGM

The pictures from the AGM on this page show Chairman Beavan presenting some of the trophies and awards. From the top they are: Martin

Condolences – We were sorry to learn of the passing recently of John (Jock) Morris ZS2MD, who had been inactive on the amateur radio scene for several years. Our sympathy goes to his family and friends.

Congratulations...

on your birthdays:

June

- 23 Denny Davies XYL of Tom ZSL037
- 28 Ken Tremeer ZS2BWB
- 28 Pieter Liebenberg ZS2PL

July

- 1 Brett Tapson
- 2 Rosemary Robertson ZR2RR
- 3 Julie Scarr ZR2EY
- 5 Nicolas Oelofse ZS2N
- 7 Jim van Loggerenberg ZS2LR
- 9 Janet Goosen XYL of ZR2AG
- 11 Isaac Greeff ZS2ZG
- 13 Cyril Hislop ZR2H
- 19 Bill Browne ZS2BY
- 19 Arthur Baynes ZR2ARB
- 20 Sally Jacobs XYL of ZS2BW
- 20 Vic Olivier ZS2SZ

on your anniversaries:

June

- 24 Blanka & Vic Batt ZR2BBH
- 24 Ali & Ewan Mathieson ZS1EM

July

- 2 Sally & Donald Jacobs ZS2BW
- 4 Marge ZS2OB & Brian Weller ZS2AB
- 12 **Julia & Bill Atteridge ZS2V – their 50th! Special congrats, you two.**
- 12 Liz & Allen Lubbe ZS2AEG
- 12 Joan & George Bowes ZS2QN
- 13 Janet & Ashley Goosen ZR2AG
- 15 Magret & Martin Ras ZR2MR

19 Charmaine & Selwyn Whitebooi
ZR2KAT

on your call signs: André Crouse now ZR2A, Wayne Pohlmann ZR2CIA, Charlene Barnes ZR2CAT, Rudy van Zyl ZR2F and Charlie Stevens ZR1AWG of George. Perhaps someone can twist the arms of the latter four new hams to join PEARS (and the SARL if they are not already enrolled there).



Sick List: Jim Duck ZR2JRD is still having a problem following his heart attack and bypass operation a couple of months ago.

Bryan Marshall ZS1NQ has recovered well from his knee operation, and Fred Strutt ZS2JS is doing OK after a back operation.

Neville Vroom ZS2VM has had a health setback after he seemed well on the way to recovery following his stroke a few months ago.

We wish you all an early, full recovery

Welcome New Members

Potchefstroom Amateur Radio Club and all their members, Glen Cummings ZR2GV, Dirk Bredenhann V51BD now living at Aston Bay, Barry Jackson ZS2H, Anne Smithers ZR2XT and Alex Gogos ZR2T. 📺

Your Society's Committee

Chairman Awards.....	Bevan Gwilt ZS2RL	360-6968
Vice Chairman, repeaters, packet, VW Rally.....	Chris Scarr ZS2AAW	368-1344
Secretary.....	Cyril Hislop ZR2H	360-8482
Treasurer Assets Control.....	Clive Fife ZS2RT	367-3203
Social Refreshments.....	Bill Hodges ZS2ABZ	581-2580
QSN Editor.....	Garth Laaks ZS2HB	368-1101
e-mail the Editor at.....	glaaks@valdica.com	
QSN distribution (ex committee).....	Trevor Scarr ZS2AF	367-1746
Technical Classes, RAE (ex committee).....	Al Akers ZS2U	360-2983
Special Events.....	Ewalt Bouwer ZS2EHB	933-3482

PEARS' VHF/UHF & Other Services

REPEATERS

Town VHF.....	# 145.050/650	
Town UHF.....	# 431.050/438.650	
Cockscomb.....	145.000/600	
Colesberg.....	* 431.075/438.675	
Cradoek.....	* 145.050/650	
Grahamstown.....	* 145.150.750	
		Knysna.....* 145.075/675
		Lady's Slipper.....* 145.100/700
		Noupoort.....* 431.150/438.750
		Uitenhage.....# 145.075/675

* These form the PEARS long-range 2-metre repeater system, also linked to which are East London 145.775 MHz, George 145.700, Danabani 145.600, Stillbaai 145.750, Butterworth 145.725, King Williams Town 145.625 and Umtata (438.725 duplex). It is further extendable to Cape Town via the WCRWG system. # These can also be linked as required.

OTHER SERVICES

Packet Bulletin Board (ZSONTP).....	144.625
Packet Rose Switch ZSOGHI-3.046101 (144.675 in/out) or 046102 (UHF out to BBS).....	144.675
2m Beacon (ZS2VHF CW ID, FSK) (horizontally polarized, 160W ERP.).....	144.415
6m Beacon (ZS2SIX CW ID) (horizontally polarized, 25W ERP).....	50.005
6m Simplex Link with Lady's Slipper 2m Repeater (vertically polarized).....	51.400
Wefax Relay (Mercosid).....	145.350

Sunday Bulletins

PEARS bulletins are transmitted on Sundays immediately after the SARI English transmission, i.e. at about 08:45, on 7098 kHz as well as the 2 metre linked network that provides coverage from East London to George as well as Cradoek and environs. PEARS' 7098 or 3640 kHz transceive facilities are also remotely linked as needed. In addition the SARI's 40m operations on 7082 or 7066 kHz or Hamnet's 7070 kHz can be remotely patched into the 2m network, in receive-only mode or with full transceive capability for interactive events.

Date	Prepare and Read on 2m Repeater link	DIARY DATES
16 Jun	ZS2EHB	<u>JUNE</u>
23	ZS2HB	21 PEARS monthly meeting
30	ZS2ABZ	<u>JULY</u>
7 Jul	ZS2RL	4 Wrinkly Rave
14	ZS2AAW	?? General meeting (to be decided)
21	ZR2H	19/20 VW Rally
28	ZS2RT	